

**THE DISPLAY CHOICE
OF PROFESSIONALS™**

HX-24E Security LED-Backlit Display

User Manual

displays.agneovo.com

TABLE OF CONTENTS

Safety Information

WEEE	1
------------	---

Precautions

Notice	2
Cautions When Setting Up	2
Cautions When Using.....	3
Cleaning and Maintenance.....	3
Notice for the LCD Display	4

Chapter 1: Product Description

1.1 Package Contents	5
1.2 Wall Mounting Installation Preparation	6
1.2.1 Wall Mounting.....	6
1.2.2 Removing the Base Stand.....	6
1.3 LCD Display Overview	7
1.3.1 Front View and Keypad Buttons.....	7
1.3.2 Rear View	8

Chapter 2: Making Connections

2.1 Connecting the Power	9
2.2 Connecting Input Source Signals	10
2.2.1 Connecting a Computer	10
Using VGA Cables	10
Using DVI Cables.....	10
Using RS-232 Cables.....	11
Connecting an Audio Device	11
2.2.2 Connecting a Camera or Video Device	12
Using CVBS Cables	12
Using SDI Cables.....	12
Using HDMI Cables.....	13
Using DisplayPort Cables	13
2.3 Connecting a USB Storage Device (For Firmware Update).....	14

Chapter 3: Using the LCD Display

3.1 Turning on the Power	15
3.2 Selecting the Input Source Signal	15
3.3 Adjusting the Volume.....	16
3.3.1 Muting the Audio.....	16
3.4 Locking the OSD Menu	16
3.5 Using FREEZE Function	17
3.6 Using Auto Adjustment Function	17

TABLE OF CONTENTS

Chapter 4: On Screen Display Menu

4.1 Using the OSD Menu	18
4.2 OSD Menu Tree	20

Chapter 5: Adjusting the Settings

5.1 Brightness	23
5.2 Colour Temp.	25
5.3 Image Setting	26
5.4 Aspect Ratio	29
5.5 Anti-Burn-In	30
5.6 OSD Setting	31
5.7 Audio Setting	32
5.8 System	33
5.9 EcoSmart.....	35
5.10 Input Select	36

Chapter 6: Appendix

6.1 Warning Messages.....	37
6.2 Troubleshooting.....	38
6.3 Transporting the LCD Display	39

Chapter 7: Specifications

7.1 Display Specifications	40
7.2 Display Dimensions.....	41
7.2.1 HX-24E Dimensions	41

SAFETY INFORMATION

WEEE

Information for users applicable in European Union countries.

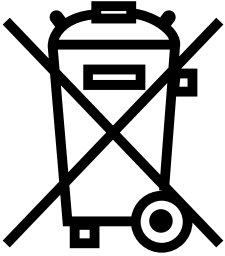

The symbol on the product or its packaging signifies that this product has to be disposed separately from ordinary household wastes at its end of life. Please kindly be aware that this is your responsibility to dispose electronic equipment at recycling centers so as to help conserve natural resources. Each country in the European Union should have its collection centers for electrical and electronic equipment recycling. For information about your recycling drop off area, please contact your local related electrical and electronic equipment waste management authority or the retailer where you bought the product.

PRECAUTIONS

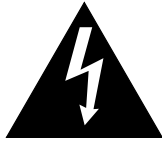

CAUTION
RISK OF ELECTRIC SHOCK
DO NOT OPEN



Symbols used in this manual

	This icon indicates the existence of a potential hazard that could result in personal injury or damage to the product.
	This icon indicates important operating and servicing information.

Notice

- Read this User Manual carefully before using the LCD display and keep it for future reference.
- The product specifications and other information provided in this User Manual are for reference only. All information is subject to change without notice. Updated content can be downloaded from our web site at displays.agneovo.com.
- To register online, go to displays.agneovo.com.
- To protect your rights as a consumer, do not remove any stickers from the LCD display. Doing so may affect the determination of the warranty period.

Cautions When Setting Up



Do not place the LCD display near heat sources, such as a heater, exhaust vent, or in direct sunlight.



Do not cover or block the ventilation holes in the housing.



Place the LCD display on a stable area. Do not place the LCD display where it may be subject to vibration or shock.



Place the LCD display in a well-ventilated area.



Do not place the LCD display outdoors.



Do not place the LCD display in a dusty or humid environment.



Do not spill liquid or insert sharp objects into the LCD display through the ventilation holes. Doing so may cause accidental fire, electric shock or damage the LCD display.

PRECAUTIONS

Cautions When Using



Use only the power cord supplied with the LCD display.



The power outlet should be installed near the LCD display and be easily accessible.



If an extension cord is used with the LCD display, ensure that the total current consumption plugged into the power outlet does not exceed the ampere rating.



Do not allow anything to rest on the power cord. Do not place the LCD display where the power cord may be stepped on.



If the LCD display will not be used for an indefinite period of time, unplug the power cord from the power outlet.



To disconnect the power cord, grasp and pull by the plug head. Do not tug on the cord; doing so may cause fire or electric shock.



Do not unplug or touch the power cord with wet hands.

Cleaning and Maintenance



The LCD display comes with NeoV™ Optical Glass. Use a soft cloth lightly moistened with a mild detergent solution to clean the glass surface and the housing.



Do not rub or tap the surface of the glass with sharp or abrasive items such as a pen or screwdriver. This may result in scratching the surface of the glass.



Do not attempt to service the LCD display yourself, refer to qualified service personnel. Opening or removing the covers may expose you to dangerous voltage or other risks.



Warning:



Unplug the power cord from the power outlet and refer to qualified service personnel under the following conditions:

- ◆ When the power cord is damaged.
- ◆ If the LCD display has been dropped or the housing has been damaged.
- ◆ If the LCD display emits smoke or a distinct odor.

PRECAUTIONS

Notice for the LCD Display

In order to maintain the stable luminous performance, it is recommended to use low brightness setting.

Due to the lifespan of the lamp, it is normal that the brightness quality of the LCD display may decrease with time.

When static images are displayed for long periods of time, the image may cause an imprint on the LCD display. This is called image retention or burn-in.

To prevent image retention, do any of the following:

- Set the LCD display to turn off after a few minutes of being idle.
- Use a screen saver that has moving graphics or a blank white image.
- Execute the Anti-Burn-In function of the LCD display. See “Settings, Anti-Burn-In” section.
- Switch desktop backgrounds regularly.
- Adjust the LCD display to low brightness settings.
- Turn off the LCD display when the system is not in use.

Things to do when the LCD display shows image retention:

- Turn off the LCD display for extended periods of time. It can be several hours or several days.
 - Use a screen saver and run it for extended periods of time.
 - Use a black and white image and run it for extended periods of time.
-

When the LCD display is moved from one room to another or there is a sudden change from low to high ambient temperature, dew condensation may form on or inside the glass surface. When this happens, do not turn on the LCD display until the dew disappears.

Due to humid weather conditions, it is normal for mist to form inside the glass surface of the LCD display. The mist will disappear after a few days or as soon as the weather stabilizes.

There are millions of micro transistors inside the LCD display. It is normal for a few transistors to be damaged and to produce spots. This is acceptable and is not considered a failure.

CHAPTER 1: PRODUCT DESCRIPTION

1.1 Package Contents

When unpacking, check if the following items are included in the package. If any of them is missing or damaged, contact your dealer.

LCD Display

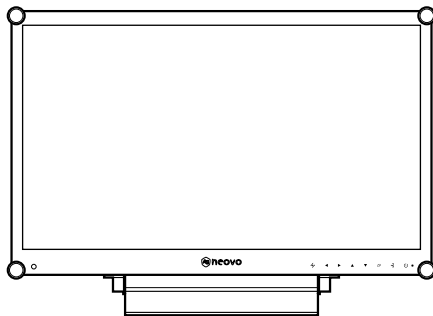

Quick Start Guide



Power adapter

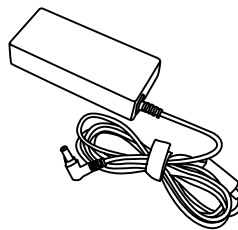

Power cord

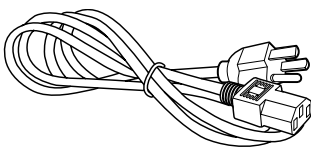

VGA cable

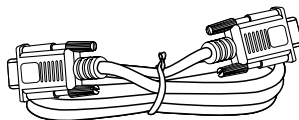

Audio cable

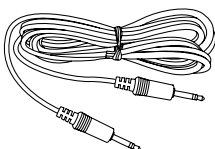

Warranty card

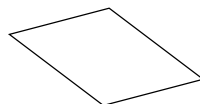

Note:

Must use only the supplied power adapter:

- ◆ Lite-on Technology Corporation
Model no. : PA-1041-81
Rating: 12V/3.33A

Note:

- ◆ The pictures are for reference only. Actual items may vary upon shipment.

PRODUCT DESCRIPTION

1.2 Wall Mounting Installation Preparation

1.2.1 Wall Mounting

1 Remove the base stand.

See procedures below.

2 Wall mount the LCD display.

Screw the mounting bracket to the VESA holes at the rear of the LCD display.

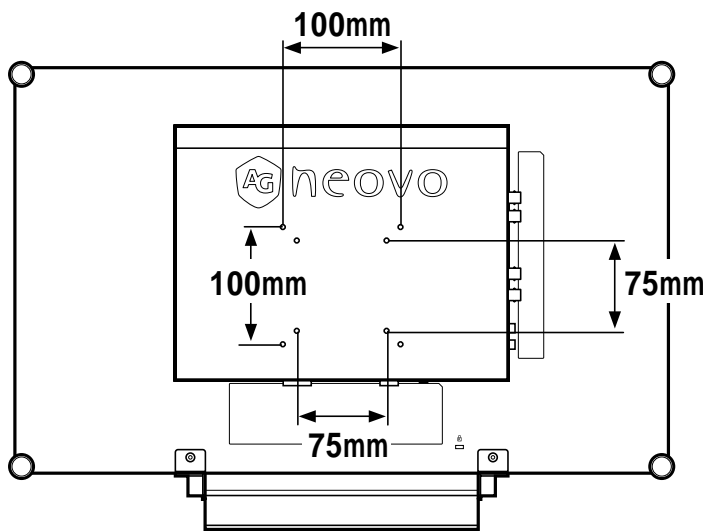

Note:

To protect the glass panel, place a towel or soft cloth before laying the LCD display down.

1.2.2 Removing the Base Stand

- 1 Lay the LCD display face down on a flat even surface.
- 2 Remove the four screws securing the base stand from the LCD display.
- 3 Detach the base stand.
- 4 Lock four screws back.

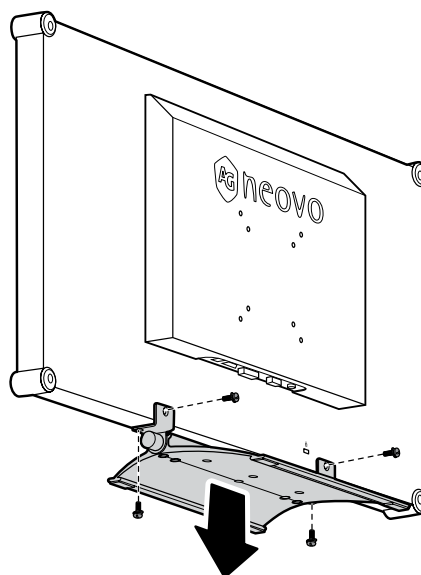

Note:

Take measures to prevent the LCD display from falling down and lessen possible injury and damage to the display in case of earthquakes or other disasters.

- ◆ Use only the 75 x 75 mm and 100 x 100 mm wall mount kit recommended by AG Neovo.
- ◆ Secure the LCD display on a solid wall strong enough to bear its weight.

PRODUCT DESCRIPTION

1.3 LCD Display Overview

1.3.1 Front View and Keypad Buttons

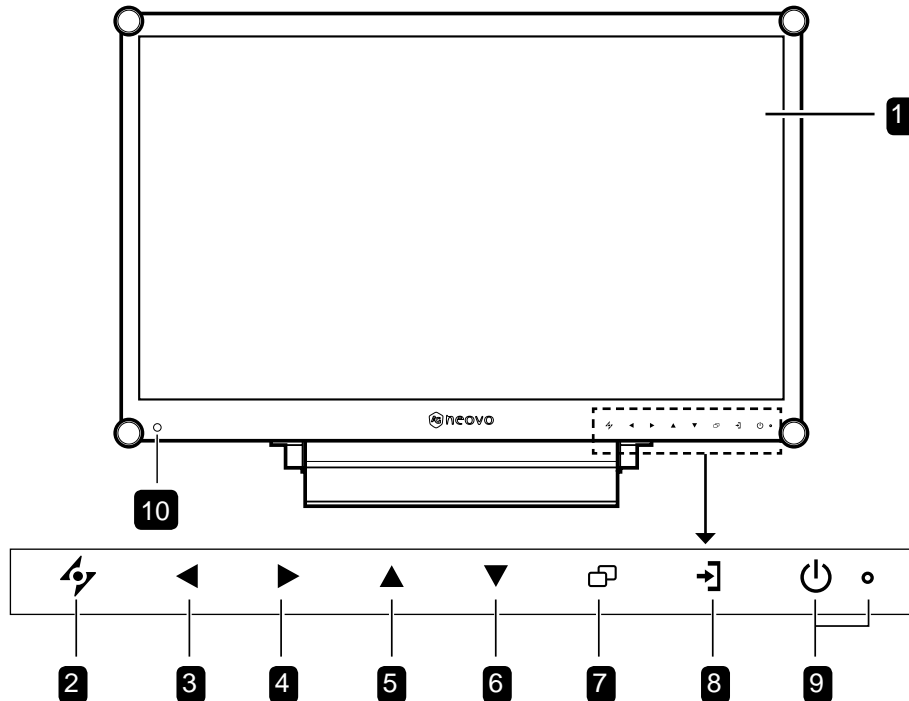

1 Display screen

The LCD display screen is protected by NeoV™ Optical Glass.

2 AUTO: Hotkey: For VGA input signal source, press to perform auto adjustment.

- During OSD menu selection, press to close the OSD menu or exit a submenu.

3 LEFT: Hot Key: Volume Down

- Press to display the volume screen. Then press again to decrease the volume.
- During OSD menu selection, press to select an option or adjust the settings.

4 RIGHT: Hot Key: Aspect Ratio

- Press to increase the volume.
- During OSD menu selection, press to select an option, adjust the settings, or enter the submenu.

5 UP: Hot Key: Screen Freeze

- During OSD menu selection, press to select an option or adjust the settings.

6 DOWN: Hot Key: Picture Mode

- During OSD menu selection, press to select an option or adjust the settings.

7 MENU: Press to display/hide the OSD menu.

8 SOURCE: Press to select the input signal source.

9 POWER / LED indicator: Press to turn the power on or off.

- Green - Power on
- Amber - Standby mode
- Off - Power off

10 EcoSmart sensor: Detect ambient lighting conditions and automatically adjust the brightness levels. Refer to page 35 "ECO SMART" for more information.

PRODUCT DESCRIPTION

1.3.2 Rear View

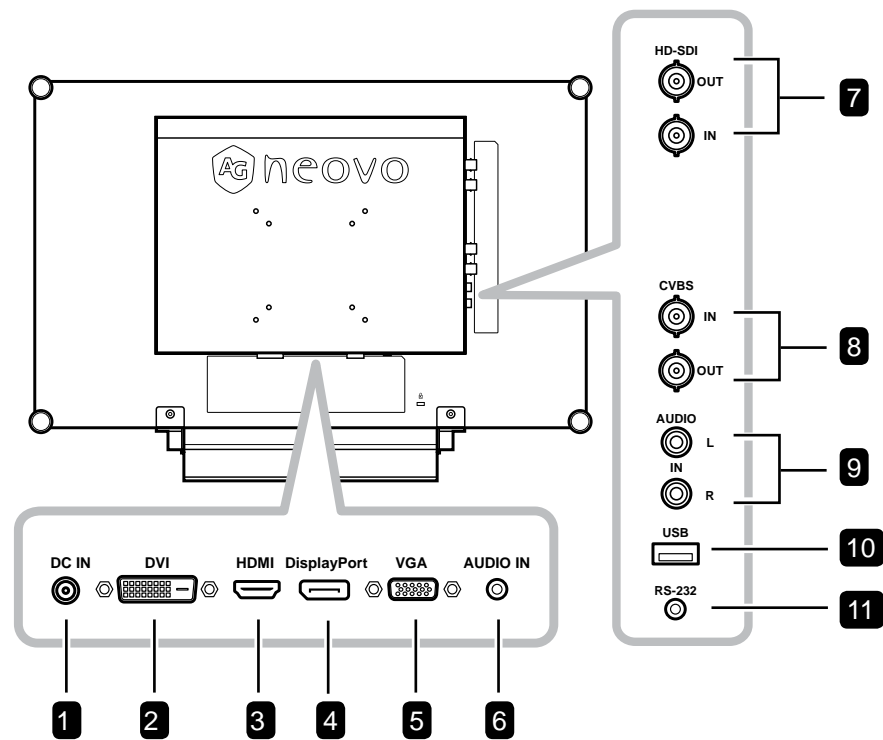

1 DC power input

Use to connect the power adapter.

2 DVI connector

Use to connect a PC using DVI cable for digital input signal.

3 HDMI connector

Use to connect an input device using HDMI cable for digital input signal.

4 DisplayPort connector

Use to connect a PC or video device using a displayport cable for digital input signal.

5 VGA connector

Use to connect a PC using a VGA cable for analogue input signal.

6 Audio port

Use to connect an audio cable for the PC's audio input.

7 HD-SDI Video input/output connectors

Use to connect SDI cable for the SDI input/output signal.

8 COMPOSITE Video input/output connectors

Use to connect composite cables for CVBS input/output signal.

9 COMPOSITE Audi input/output connectors

Use to connect composite cables for CVBS input/output signal.

10 USB connector (For FW update)

Use to connect USB compatible storage device for firmware update.

11 RS-232 connector

Use to connect an RS-232 cable for network output / input for the loop-through function.

CHAPTER 2: MAKING CONNECTIONS

2.1 Connecting the Power

- 1 Connect the power cord to the power adapter.
- 2 Connect the power adapter to the DC power input at the rear of the LCD display.
- 3 Connect the power cord plug to a power outlet or a power supply.

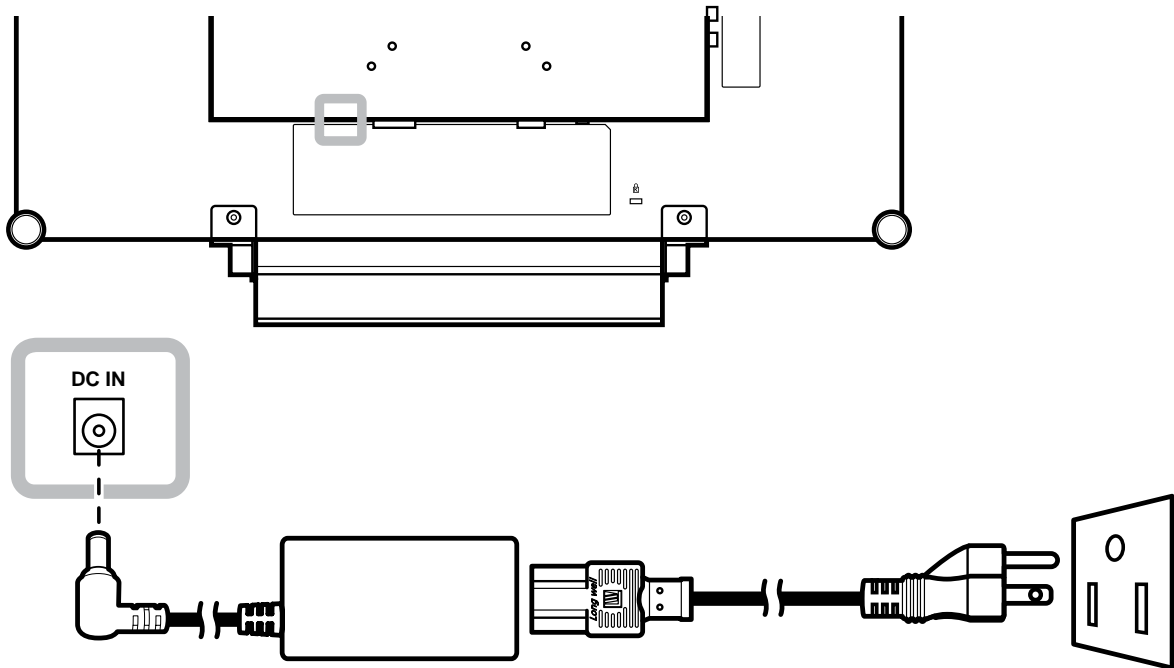

Caution:

- ◆ Make sure that the LCD display is not connected to the power outlet before making any connections. Connecting cables while the power is ON may cause electric shock or personal injury.



Caution:

- ◆ When unplugging the power cord, hold the power cord by the plug head. Never pull by the cord.

MAKING CONNECTIONS

2.2 Connecting Input Source Signals

2.2.1 Connecting a Computer

Using VGA Cables

Connect one end of a D-sub cable to the VGA connector of the LCD display and the other end to the D-sub connector of the computer.

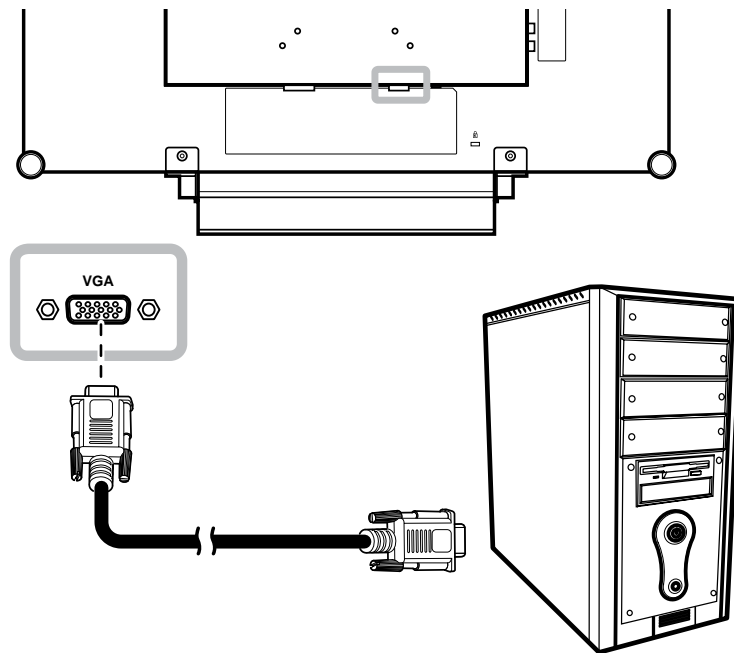

Using DVI Cables

Connect one end of a DVI cable to the DVI connector of the LCD display and the other end to the DVI connector of the computer.

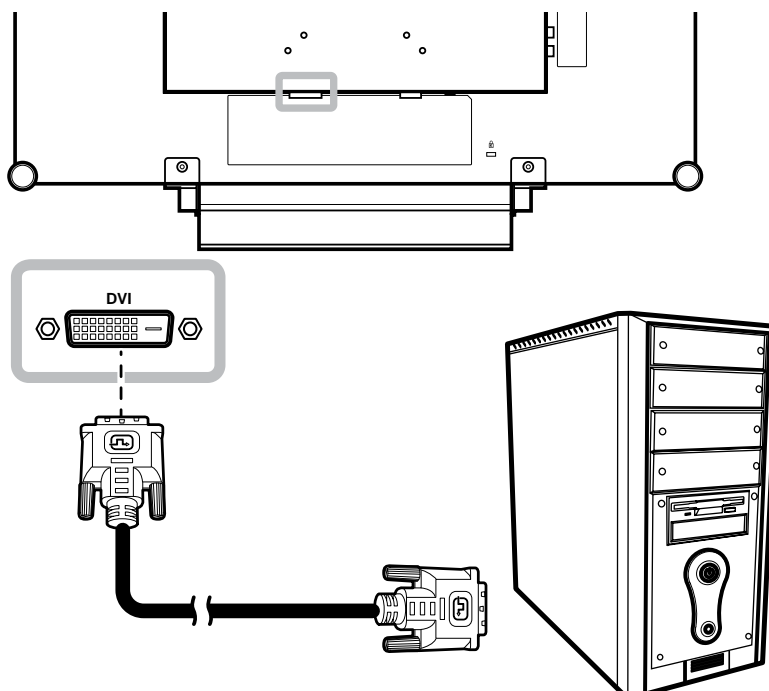

MAKING CONNECTIONS

Using RS-232 Cables

Connect one end of an RS-232 cable to the RS-232 connector of the LCD display and the other end to the RS-232 connector of the computer.

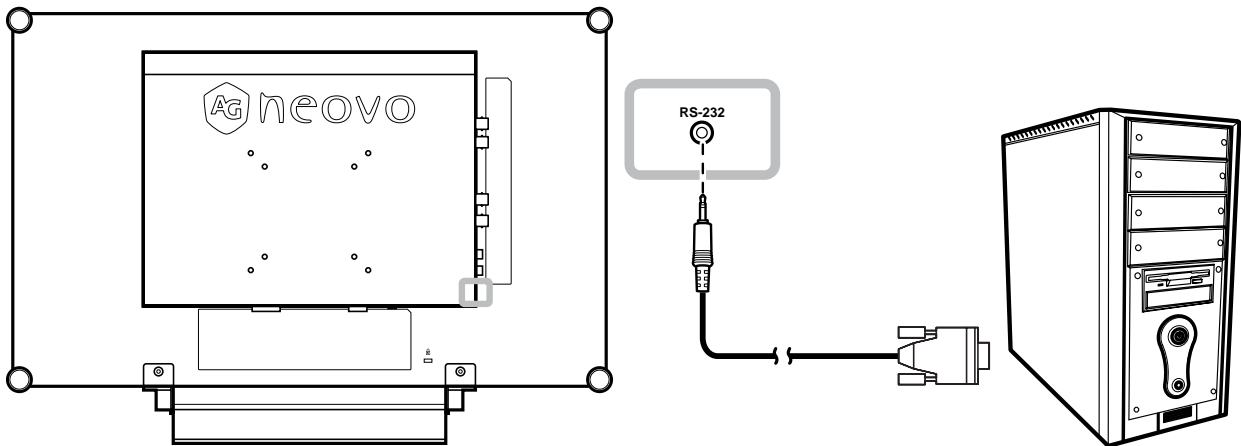

Connecting an Audio Device

Connect one end of an audio cable to the audio port of the LCD display and the other end to the audio out port of the computer.

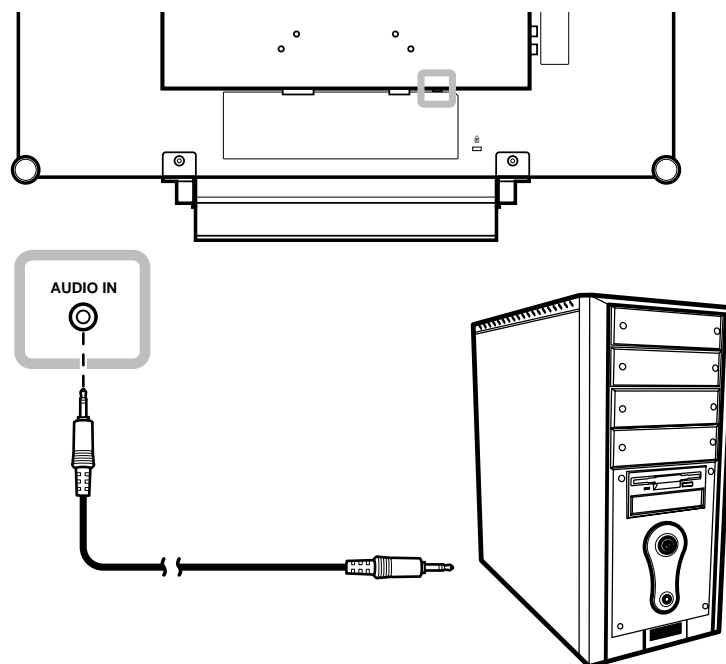

MAKING CONNECTIONS

2.2.2 Connecting a Camera or Video Device

Using CVBS Cables

Connect one end of a CVBS cable to the COMPOSITE IN connector of the LCD display and the other end to the COMPOSITE OUT connector of your device.

For audio input, connect an RCA cable to the audio in connector of the LCD display and the audio out connector of your device.

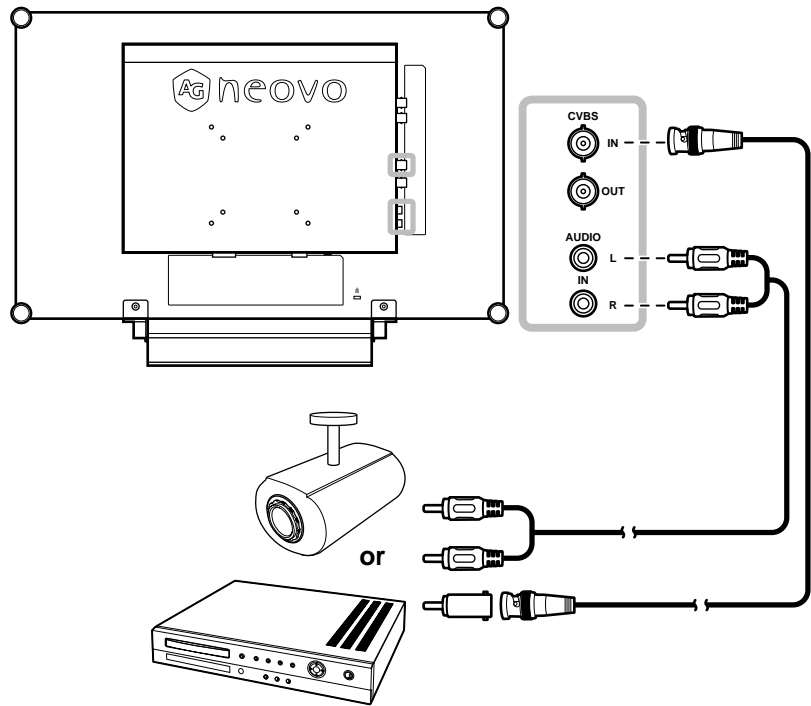

Using SDI Cables

Connect one end of an SDI cable to the SDI connector of the LCD display and the other end to the SDI connector of your device.

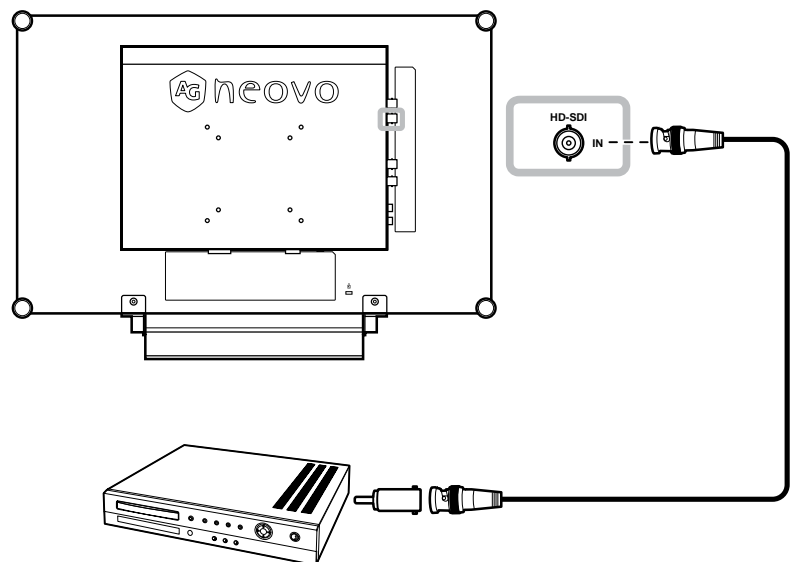

MAKING CONNECTIONS

Using HDMI Cables

Connect one end of an HDMI cable to the HDMI connector of the LCD display and the other end to the HDMI connector of your device.

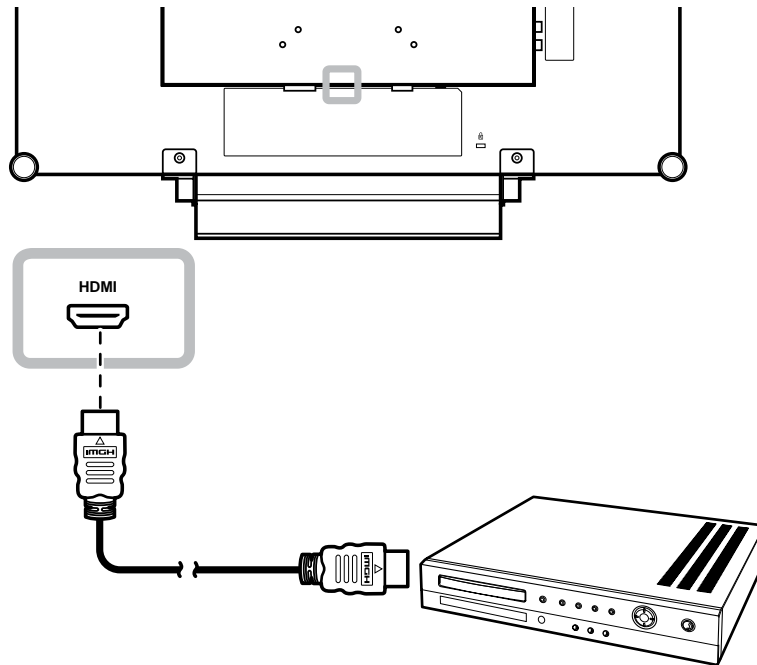

Using DisplayPort Cables

Connect one end of a DisplayPort cable to the DisplayPort connector of the LCD display and the other end to the DisplayPort connector of your device.

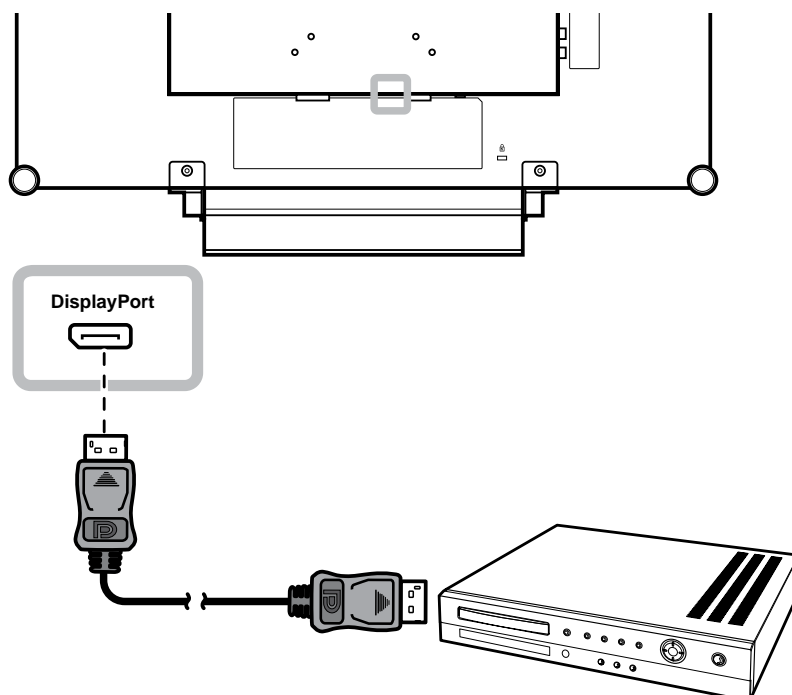

MAKING CONNECTIONS

2.3 Connecting a USB Storage Device (For Firmware Update)

Do any of the following to connect a USB storage device to the USB connector of the LCD:

- Connect the USB storage device directly to the USB connector of the LCD (as illustrated below).
- Connect one end of a USB cable to the USB connector of the LCD monitor and the other end to the USB connector of the storage device.

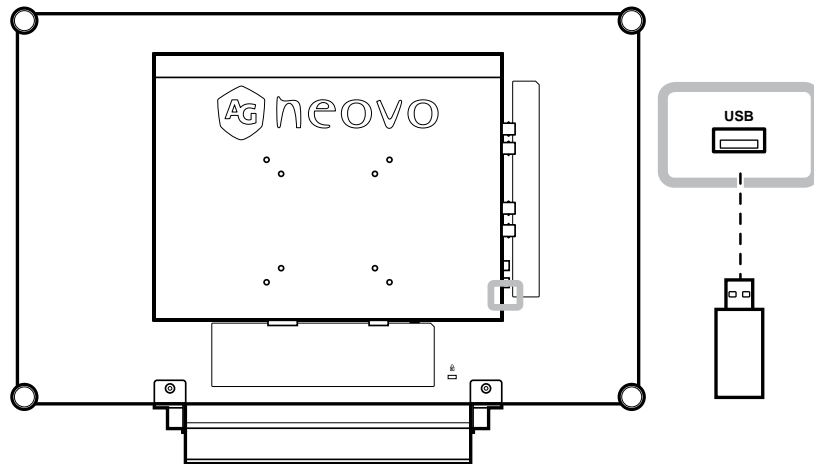

CHAPTER 3: USING THE LCD DISPLAY

3.1 Turning on the Power

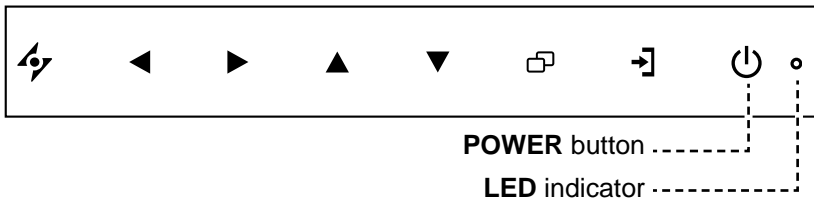

1 Plug the power cord to a power outlet or power supply.

2 Touch the **POWER** button to turn the LCD display on.

The LED indicator turns GREEN.

When the LCD display is turned on, touch the POWER button to turn off the LCD display.

The LED indicator turns off.

3.2 Selecting the Input Source Signal

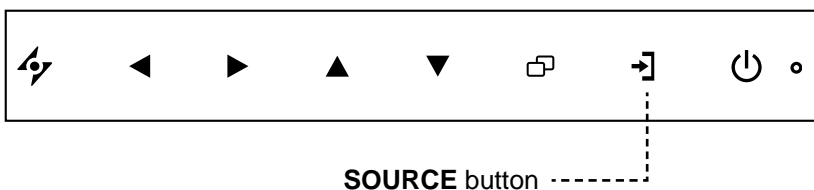

Touch the  button to select the input source signal.

Note:

- ◆ The LCD display still consumes power as long as the power cord is connected to the power outlet. Disconnect the power cord to completely cut off power.

Notes:

- ◆ After selecting an input source signal, the input source signal message appears on the screen briefly.

For example, CVBS is selected the following message is displayed.



- ◆ If the selected input source signal is not connected to the LCD display or is turned off, the no signal message is displayed on the screen.



- ◆ If the resolution or the graphics card of the connected computer is set too high, the input out of range message is displayed.



USING THE LCD DISPLAY

3.3 Adjusting the Volume

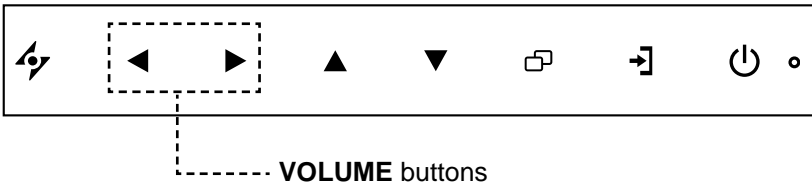

1 Touch the ◀ button to call out the volume bar.

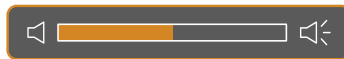

2 Touch the ▶ button to increase volume or the ◀ button to decrease volume.

3.3.1 Muting the Audio

Touch the ◀ and the ▶ buttons simultaneously to mute or unmute the audio.

3.4 Locking the OSD Menu

Lock the OSD menu to protect the LCD display from unauthorised users or from accidentally pressing the keypad.

To lock the OSD, press and hold the keypad buttons listed below for at least 5 seconds or until the



message appears.

When the OSD is locked, all keypad buttons are inactivated.

Type of OSD Lock	Lock Operation	Unlock Operation
Lock all buttons	Touch and hold the ▶, ▲, and the ▼ buttons for 5 seconds.	Touch and hold the ▶, ▲, and the ▼ buttons for 5 seconds or until the OSD menu appears.
Lock all buttons except the POWER button.	Touch and hold the ◀, ▲, and the ▼ buttons for 5 seconds.	Touch and hold the ◀, ▲, and the ▼ buttons for 5 seconds or until the OSD menu appears.

USING THE LCD DISPLAY

3.5 Using FREEZE Function

The FREEZE function allows you to freeze the screen image but still continues real-time playback until the image is unfreeze.

Touch the ⚡ button to activate screen freeze, the screen freeze message is displayed on the screen.



Touch the ⚡ button again to deactivate screen freeze.

The screen image displays the elapsed real-time playback image when screen freeze is deactivated.



3.6 Using Auto Adjustment Function

Auto Adjustment function automatically tunes the LCD display to its optimal setting, including horizontal position, vertical position, clock, and phase.

Touch the ⚡ button to perform auto adjustment.

The message auto adjusting is displayed on the screen.



During auto adjustment, the screen will slightly shake for a few seconds.

When the message disappears, auto adjustment is completed.

Note:



- ◆ The FREEZE function is available only during video input signals.

Note:

- ◆ Auto Adjustment function is available only during VGA input signals.
- ◆ It is recommended to use the auto adjustment function when using the LCD display for the first time or after a resolution or frequency change.

CHAPTER 4: ON SCREEN DISPLAY MENU

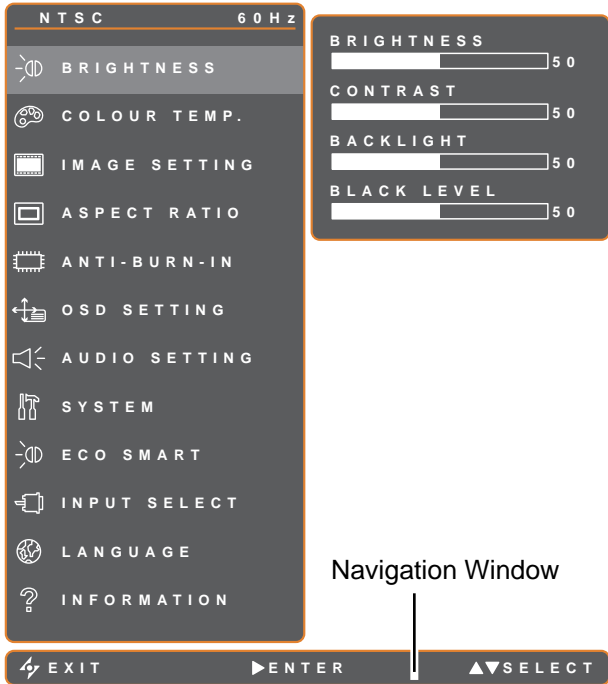
4.1 Using the OSD Menu

		Operation
1	<p>Display the main menu screen.</p> 	<p>Touch .</p>
2	<p>Select the menu.</p> 	<ol style="list-style-type: none">1 Touch the ▲ or ▼ buttons.2 Touch the ► button to enter the submenu.

ON SCREEN DISPLAY MENU

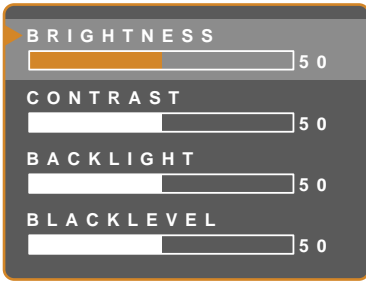
		Operation
<p>3 Select the submenu item.</p>  <p>The highlighted item with an orange arrow indicates the active submenu.</p>	<p>Touch the ▲ or ▼ buttons.</p>	
<p>4 Adjust the settings.</p>	<p>Touch the ◀ or ▶ buttons.</p>	
<p>5 Exit the submenu.</p>	<p>Touch ⚡ or ◻ to return to the previous menu.</p>	
<p>6 Close the OSD window.</p>	<p>Touch ⚡ or ◻ again.</p>	

When settings are modified, all changes are saved when the user does the following:

- Proceeds to the another menu.
- Exits the OSD menu.
- Waits for the OSD menu to disappear.

Note: Availability of some menu items depend on the input source signal. If the menu is not available, it is disabled and grayed out.

ON SCREEN DISPLAY MENU

4.2 OSD Menu Tree

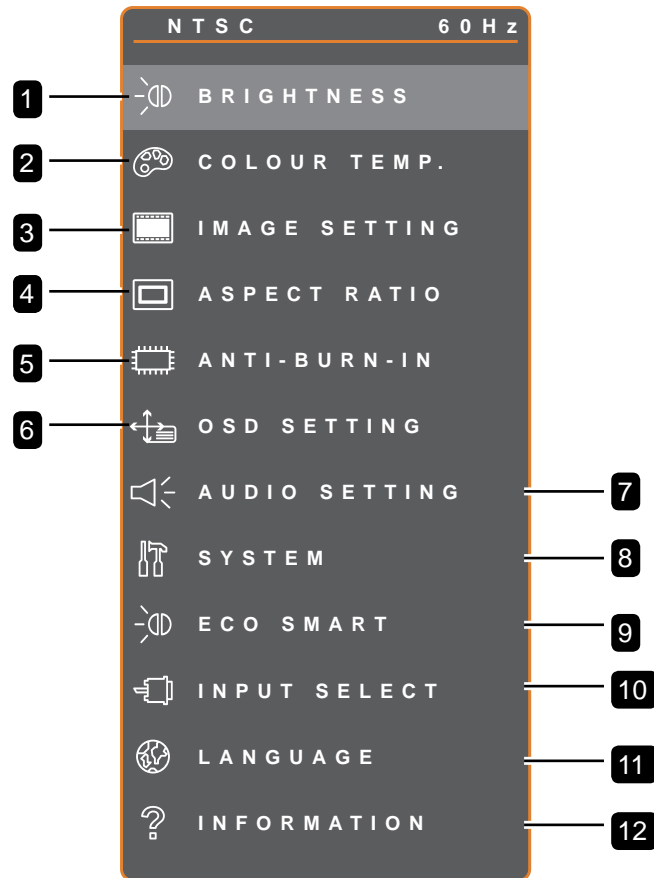

Main Menu	Submenu	Remarks
1. BRIGHTNESS	<ul style="list-style-type: none"> • BRIGHTNESS • CONTRAST • BACKLIGHT • BLACKLEVEL 	Refer to pages 23-24
2. COLOUR TEMP.	<ul style="list-style-type: none"> • NEUTRAL • WARM • COOL • USER • AUTO COLOUR 	Refer to page 25

ON SCREEN DISPLAY MENU

Main Menu	Submenu	Remarks
3. IMAGE SETTING	<ul style="list-style-type: none"> • SHARPNESS • SATURATION • TINT • GAMMA • COLOR RANGE • NOISE REDUCTION • PICTURE MODE • H. POSITION • V. POSITION • PHASE • CLOCK 	Refer to pages 26-28
4. ASPECT RATIO	<ul style="list-style-type: none"> • FULL • REAL • NATIVE • ZOOM • OVERSCAN 	Refer to page 29
5. ANTI-BURN-IN	<ul style="list-style-type: none"> • ENABLE • INTERVAL (HOURS) • MODE 	Refer to page 30
6. OSD SETTING	<ul style="list-style-type: none"> • TRANSPARENCY • OSD H. POSITION • OSD V. POSITION • OSD TIMER 	Refer to page 31
7. AUDIO SETTING	<ul style="list-style-type: none"> • VOLUME • AUDIO • SOURCE 	Refer to page 32
8. SYSTEM	<ul style="list-style-type: none"> • POWER SAVING • SOURCE DETECT • DDC/CI • DCR • BLUE SCREEN • SIGNAL INFO • HDMI CEC • LOGO • LED • MONITOR-ID • RECALL 	Refer to pages 33-34





ON SCREEN DISPLAY MENU

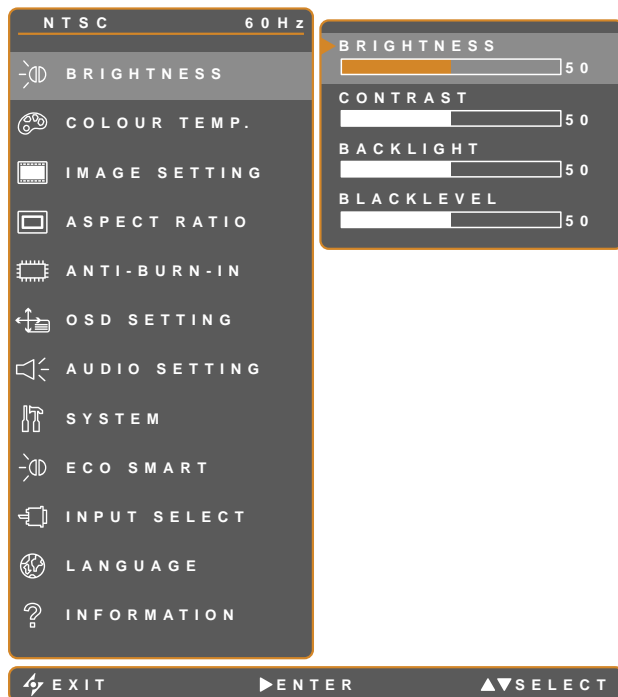

Main Menu	Submenu	Remarks
9. ECO SMART	<ul style="list-style-type: none"> • ENABLE • MODE • LEVEL 	Refer to page 35
10. INPUT SELECT	<ul style="list-style-type: none"> • VGA • DVI • HDMI • DP • CVBS • SDI 	Refer to page 36
11. LANGUAGE	SELECT THE OSD LANGUAGE: EN / FR / DE / ES / IT / PY / RO / PL / CS / NL / 简中 / 繁中	
12. INFORMATION	Displays settings information such as Input, Resolution, Horizontal and Vertical Frequency, Timing mode, and Firmware version.	

CHAPTER 5: ADJUSTING THE LCD DISPLAY

5.1 Brightness



1. Touch  to call out the OSD window.
2. Select **BRIGHTNESS** menu, then touch the  button.
3. Touch the  or  button to select an option.

Item	Function	Operation	Range
BRIGHTNESS	Adjusts the luminance of the screen image.		
CONTRAST	Adjusts the difference between the black level and the white level.		
BACKLIGHT	Adjusts the luminance of the screen image. Note: This menu option is not available if the ECO SMART function is enabled.	Touch the  or  button to adjust the value.	0 to 100
BLACKLEVEL	Adjusts the black level of the screen image. Low brightness setting makes black colour darker. Note: This menu option is not available if the input source is VGA or DVI.		

Refer to comparison illustrations on page 24.





ADJUSTING THE LCD DISPLAY









	Original Setting	High Setting	Low Setting
BRIGHTNESS			
CONTRAST			
BLACK LEVEL			

ADJUSTING THE LCD DISPLAY

5.2 Colour Temp.







1. Touch  to call out the OSD window.
2. Select **COLOUR TEMP.** menu, then touch the  button.
3. Touch the  or  button to select an option.



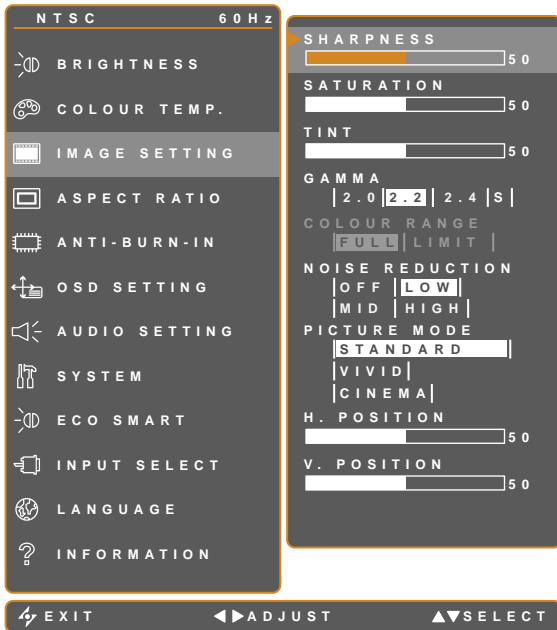





Item	Function	Operation	Value
COLOUR TEMP.	Provides several colour settings	Touch the  or  button to select the setting.	NEUTRAL WARM COOL USER AUTO COLOUR
	<p>Colour setting can be set to:</p> <ul style="list-style-type: none"> • NEUTRAL - Commonly used for normal lighting conditions. • WARM - Applies a reddish tint for warmer colours. • COOL - Applies a bluish tint for cooler colours. • USER - This allows users to set the colour temperature by adjusting the R, G, B settings according to one's preference. <ol style="list-style-type: none"> 1 Select USER, then touch the  button 2 Touch the  or  button to select among R, G, B option. 3 Touch the  or  button to adjust the values between 0 ~ 255. <p>Note: Activate RECALL to return the colour to its default setting.</p> • AUTO COLOUR - Operates the white balance and automatically adjusts the colour settings. <ol style="list-style-type: none"> 1 Select AUTO COLOUR. 2 Touch the  button to activate auto colour. <p>Note: This menu option is only available if the input source is VGA.</p> 		

ADJUSTING THE LCD DISPLAY

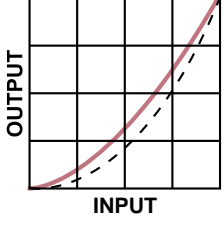
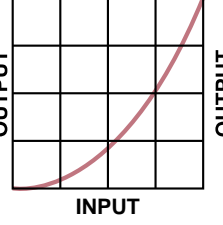
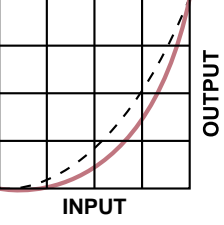
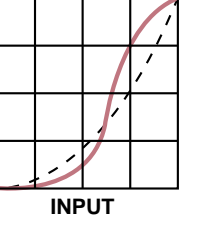

5.3 Image Setting



1. Touch  to call out the OSD window.
2. Select **IMAGE SETTING** menu, then touch the  button.
3. Touch the  or  button to select an option.

Item	Function	Operation	Range
SHARPNESS	Adjusts the clarity and focus of the screen image.	Touch the  or  button to adjust the value.	0 to 100
SATURATION	Adjusts the colour saturation.		
TINT	Adjusts the colour tint.		
GAMMA	Adjusts the non-linear setting for picture luminance and contrast.	Touch the  or  button to select the setting.	2.0
			2.2
			2.4
			S
		   	
		   	

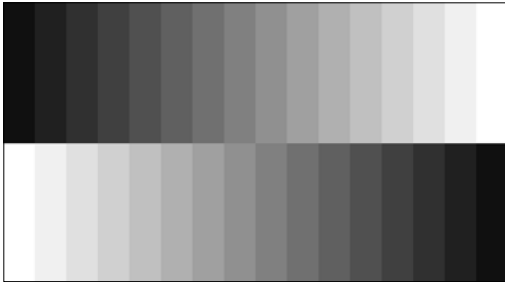
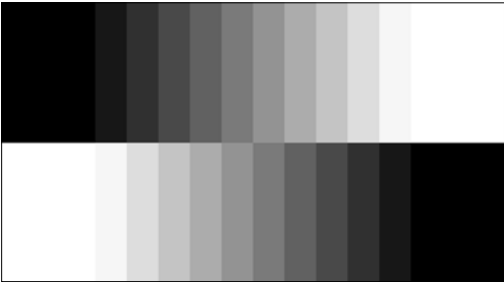
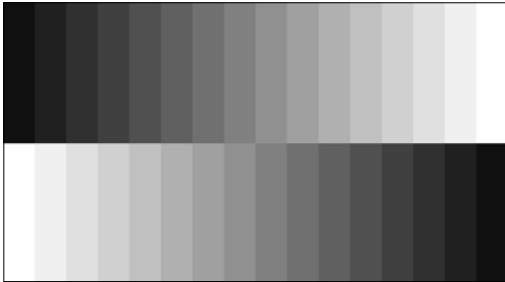
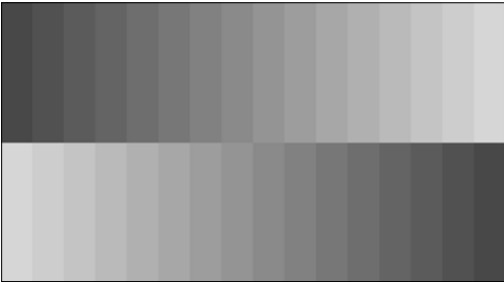
ADJUSTING THE LCD DISPLAY

Item	Function	Operation	Range	
COLOUR RANGE	Adjusts black and white levels for video. Note: This menu option is only available if the input source is HDMI or DP.	Touch the ◀ or ▶ button to select the setting.	FULL LIMIT	
	Signal source from PC - PC signal at a full range (Grayscale 0-255) state:			
			Monitor OSD colour range: Full *Please select Monitor OSD colour range: Limit	
	Signal source from Video - Video signal at a limited range (Grayscale 16-235) state:			
			Monitor OSD colour range: Limit *Please select Monitor OSD colour range: Full	
NOISE REDUCTION	Adjusts the noise reduction to help remove noise from images. This helps produce clearer and crisper images.	Touch the ◀ or ▶ button to select the setting.	OFF LOW MID HIGH	
			Noise Reduction Off Noise Reduction On	
PICTURE MODE	Selects a predefined picture mode setting.	Touch the ◀ or ▶ button to select the setting.	STANDARD VIVID CINEMA	

ADJUSTING THE LCD DISPLAY

Item	Function	Operation	Range
H. POSITION (Horizontal Position)	Moves the screen image to the left or right.	Touch the ◀ or ▶ button to adjust the value.	0 to 100
V. POSITION (Vertical Position)	Moves the screen image up or down.		
PHASE	Adjusts the phase timing to synchronise with the video signal. Note: This menu option is only available if the input source is VGA.		
CLOCK	Adjusts the frequency timing to synchronise with the video signal. Note: This menu option is only available if the input source is VGA.		

* Each item function might vary for different input sources under different picture modes.

Picture Mode	Item	VGA	DVI	VIDEO/ HD	S-VIDEO	HDMI	SDI	DP
STANDARD	SHARPNESS	V	V	V	V	V	V	V
	SATURATION	X	X	V	V	X	V	X
	TINT	X	X	V	V	X	V	X
	GAMMA	V	V	V	V	V	V	V
	COLOR RANGE	X	X	X	X	X	V	X
	NOISE REDUCTION	X	X	V	V	X	V	X
	PICTURE MODE	V	V	V	V	V	V	V
	H. POSITION	V	V	V	V	V	V	V
	V. POSITION	V	V	V	V	V	V	V
	PHASE	V	X	X	X	X	X	X
CLOCK	V	X	X	X	X	X	X	
VIVID / CINEMA	SHARPNESS	V	V	V	V	V	V	V
	SATURATION	V	V	V	V	V	V	V
	TINT	V	V	V	V	V	V	V
	NOISE REDUCTION	V	V	V	V	V	V	V
	PICTURE MODE	V	V	V	V	V	V	V
	H. POSITION	V	V	V	V	V	V	V
	V. POSITION	V	V	V	V	V	V	V
	PHASE	V	X	X	X	X	X	X
CLOCK	V	X	X	X	X	X	X	
VIVID	GAMMA	2.2	2.2	2.2	2.2	2.2	2.2	2.2
	COLOR RANGE	X	X	X	X	V	V	V
CINEMA	GAMMA	S	S	S	S	S	S	S
	COLOR RANGE	X	X	V	X	V	V	V

V Enable / X Disable

ADJUSTING THE LCD DISPLAY

5.4 Aspect Ratio



1. Touch to call out the OSD window.
2. Select **ASPECT RATIO** menu, then touch the button.
3. Touch the or button to select an option.

Item	Function	Operation	Value
ASPECT RATIO	Adjusts the aspect ratio of the screen image.	Touch the or button to select the setting.	FULL REAL NATIVE ZOOM
H. ZOOM (Horizontal Zoom)	Adjusts the horizontal zoom. Note: This menu option is only available if the ASPECT RATIO setting is set to ZOOM .	Touch the or button to adjust the value.	0 to 100
V. ZOOM (Vertical Zoom)	Adjusts the horizontal zoom. Note: This menu option is only available if the ASPECT RATIO setting is set to ZOOM .		
OVERSCAN	Adjusts the overscan setting to fix the cut-off screen edges.		

* ASPECT RATIO function might vary for each input sources under different picture modes.





Picture Mode	VGA	DVI	VIDEO/HD	S-VIDEO	HDMI	SDI	DP
STANDARD	X	X	V	V	X	V	V
VIVID	V	V	V	V	V	V	V
CINEMA	V	V	V	V	V	V	V



V Enable / X Disable

ADJUSTING THE LCD DISPLAY

5.5 Anti-Burn-In







1. Touch  to call out the OSD window.
2. Select **ANTI-BURN-IN** menu, then touch the  button.
3. Touch the  or  button to select an option.



Item	Function	Operation	Value
ENABLE	Enables or disables Anti-Burn-In function.	Touch the  or  button to select the setting.	ON OFF
INTERVAL (HOURS)	Sets the interval time (hour) between activating the Anti-Burn-In function.		4 5 6 8
MODE	Selects the Anti-Burn-In mode. Anti-Burn-In mode can be set to. <ul style="list-style-type: none"> • A - Executes fast. • B - Slower but more precise than mode A. • C - Slowest but the most precise anti-burn-in mode. 		A B C

ADJUSTING THE LCD DISPLAY

5.6 OSD Setting







1. Touch  to call out the OSD window.
2. Select **OSD SETTING** menu, then touch the  button.
3. Touch the  or  button to select an option.





Item	Function	Operation	Range
TRANSPARENCY	Adjusts the transparency level of the OSD screen.	Touch the  or  button to adjust the value.	0 to 100
OSD H. POSITION (Horizontal Position)	Moves the OSD window to the left or right of the screen.		
OSD V. POSITION (Vertical Position)	Moves the OSD window up or down the screen.		
OSD TIMER	Sets the length of time (in seconds) the OSD screen is displayed. When the time elapses, the OSD screen is automatically inactivated.		5 to 100

ADJUSTING THE LCD DISPLAY

5.7 Audio Setting







1. Touch  to call out the OSD window.
2. Select **AUDIO SETTING** menu, then touch the  button.
3. Touch the  or  button to select an option.

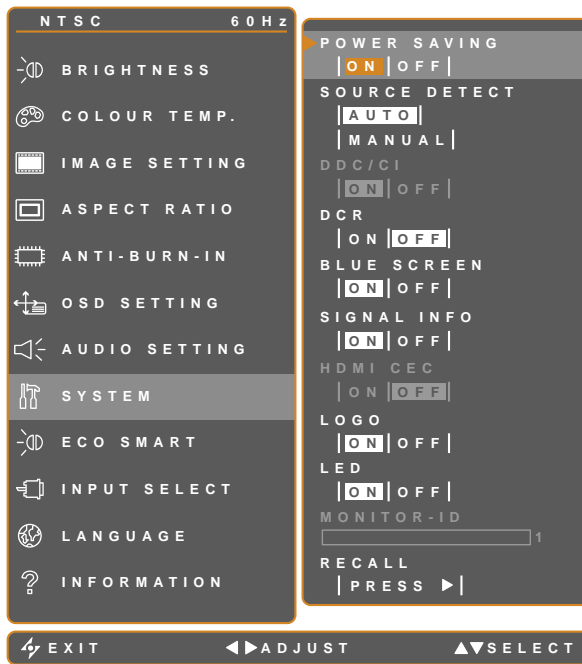

Item	Function	Operation	Range / Value
VOLUME	Adjusts the volume level of the built-in speaker. Note: If volume is adjusted but AUDIO is set to OFF , no sound comes out from the speaker.	Touch the  or  button to adjust the value.	0 to 100
AUDIO	Turns the audio speaker ON or OFF.		ON OFF
SOURCE	Selects the audio source for the PC or Video input signal. Note: This menu option is only available if the input source is HDMI or SDI.	Touch the  or  button to select the value.	PC VIDEO

ADJUSTING THE LCD DISPLAY

5.8 System



1. Touch  to call out the OSD window.
2. Select **SYSTEM** menu, then touch the  button.
3. Touch the  or  button to select an option.

Item	Function	Operation	Range / Value
POWER SAVING	Enables or disables power saving mode. When the LCD display turns into power saving mode, the screen turns black and the LED indicator lights AMBER. Note: The amount of time for the display to enter power saving varies depending on the SOURCE DETECT setting. If the SOURCE DETECT is set to AUTO , the display checks all input source signals before entering power saving mode if no signal is detected; this takes up more time. If the SOURCE DETECT is set to MANUAL , the display enters power saving mode right away.	Touch the  or  button to select the setting.	ON OFF
SOURCE DETECT	Sets the display to automatically or manually detect the input source signal.		AUTO MANUAL
DDC/CI	Activates the DDC/CI protocol to allow users to configure the monitor by a software using two wires on the VGA, DVI, HDMI, SDI, or DP cables.		ON OFF
DCR (Dynamic Contrast Ratio)	Activates DCR. This feature provides automatic adjustment of picture brightness and contrast at high speed and dynamic contrast range, such as when watching movies. DCR is suitable for indoor viewing.		

ADJUSTING THE LCD DISPLAY





Item	Function	Operation	Range / Value
BLUE SCREEN	Enables or disables the blue screen feature. If the setting is set to ON , it displays a blue screen when no signal is available	Touch the ◀ or ▶ button to select the setting.	ON OFF
SIGNAL INFO	Enables or disables the signal information to be displayed on the screen		
HDMI CEC	Enables or disables the HDMI CEC feature. If the setting is set to ON , you can control the connected HDMI CEC-compatible device on the same power on or power off status. Note: This menu option is only available if the input source is HDMI or DP.		
LOGO	Enables or disables the logo feature. If the setting is set to ON , the AG Neovo logo is briefly displayed after the display is powered on.		
LED	Turns the LED indicator on or off while using the LCD monitor.		
MONITOR-ID	Sets the monitor ID.	Touch the ◀ or ▶ button to set the ID.	0-255
RECALL	Use to recall all to default settings, except Language and the input source.	Touch the ▶ button to execute the function.	



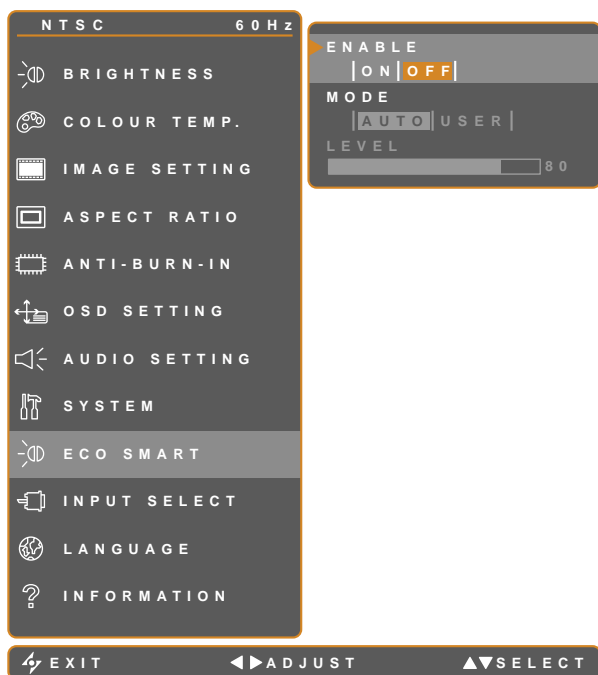

ADJUSTING THE LCD DISPLAY

5.9 EcoSmart

With the built-in EcoSmart sensor, users can enable the Eco Smart feature to automatically adjust the LCD screen brightness according to the ambient light. This feature comforts the eyes and helps optimise energy efficiency.







1. Touch  to call out the OSD window.
2. Select **ECO SMART** menu, then touch the  button.
3. Touch the  or  button to select an option.

Item	Function	Operation	Value
ENABLE	Enables or disables the Eco Smart feature.	Touch the  or  button to select the value.	ON OFF
MODE	Sets the auto brightness mode.		AUTO USER
	The mode can be set to: <ul style="list-style-type: none"> • AUTO - This mode is the default mode. The LCD brightness automatically adjusts to the ambient brightness. • USER - Allows you to manually adjust the LCD brightness. 		
LEVEL	Allows you to set the level of LCD brightness. Note: This menu option is only available if the MODE setting is set to USER .	Touch the  or  buttons to adjust the value.	0 to 100

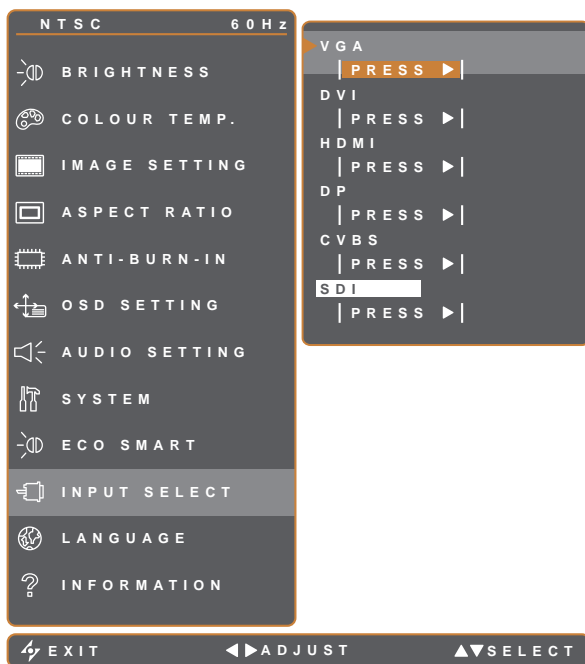
ADJUSTING THE LCD DISPLAY

5.10 Input Select









1. Touch  to call out the OSD window.
2. Select **INPUT SELECT** menu, then touch the  button.
3. Touch the  or  button to select an option.

Item	Function	Operation	Value
VGA	Sets VGA as the input source signal.	Touch the  button to select the input source.	-
DVI	Sets DVI as the input source signal.		
HDMI	Sets HDMI as the input source signal.		
DP	Sets DP (DisplayPort) as the input source signal.		
CVBS	Sets CVBS as the input source signal.		
SDI	Sets SDI as the input source signal.		

CHAPTER 6: APPENDIX

6.1 Warning Messages

Warning Messages	Cause	Solution
	The resolution or the refresh rate of the graphics card of the computer is set too high.	<ul style="list-style-type: none"> • Change the resolution or the refresh rate of the graphics card.
	The LCD display cannot detect the input source signal.	<ul style="list-style-type: none"> • Check if the input source is turned ON. • Check if the signal cable is properly connected. • Check if any pin inside the cable connector is twisted or broken.
	The OSD has been locked by the user.	<ul style="list-style-type: none"> • Unlock the OSD. Refer to page 16.
	The audio has been muted by the user.	<ul style="list-style-type: none"> • Unmute the audio or increase the volume. Refer to page 16.
	The Anti-Burn-In function has been enabled by the user.	<ul style="list-style-type: none"> • Disable Anti-Burn-In function. Refer to page 30.
	The Anti-Burn-In function has been disabled by the user.	<ul style="list-style-type: none"> • Enable Anti-Burn-In function. Refer to page 30.

APPENDIX

6.2 Troubleshooting

Problem	Possible Cause and Solution
No picture. <ul style="list-style-type: none"> LED indicator is OFF. 	<ul style="list-style-type: none"> Check if the LCD display is turned ON. Check if the power adapter is properly connected to the LCD display. Check if the power cord is plugged into the power outlet.
<ul style="list-style-type: none"> LED indicator is AMBER. 	<ul style="list-style-type: none"> Check if the computer is turned ON. Check if the computer is in standby mode, move the mouse or press any key to wake up the computer.
Image position is incorrect.	<ul style="list-style-type: none"> Adjust the H. POSITION and V. POSITION values. Refer to IMAGE SETTING on page 28.
The displayed texts are blurry.	<ul style="list-style-type: none"> For VGA input, touch  on the keypad to auto-adjust the display. Adjust the IMAGE SSETTING, refer to page 17.
The OSD menu can't be called out.	<ul style="list-style-type: none"> The OSD is locked. To unlock the OSD, refer to page 16.
Red, blue, green, white dots appear on screen.	<ul style="list-style-type: none"> There are millions of micro transistors inside the LCD display. It is normal for a few transistors to be damaged and to produce spots. This is acceptable and is not considered a failure.
No audio output.	<ul style="list-style-type: none"> Check if the volume is set to 0, refer to Audio Mute on page 16. Check if the AUDIO SETTING > AUDIO setting is set to OFF (refer to page 16). For VGA or DVI input, check the audio setting of the computer. For HDMI or DP input, select the correct audio input source, refer to page 32.
Cannot adjust backlight setting.	<ul style="list-style-type: none"> The Eco Smart feature is enabled. Set the ECO SMART > ENABLE setting to OFF to disable the Eco Smart feature, refer to page 35.
The displayed picture looks distorted.	<ul style="list-style-type: none"> Adjust the aspect ratio, refer to page 29.
Dew formed on or inside the LCD display.	<ul style="list-style-type: none"> This normally happens when the LCD display is moved a cold room to a hot room temperature. Do not turn ON the LCD display, wait for the dew condensation to disappear.
Mist formed inside the glass surface.	<ul style="list-style-type: none"> This happens due to humid weather conditions. This is a normal occurrence. The mist will disappear after a few days or as soon as the weather stabilizes
Faint shadows from a static image appear on the screen.	<ul style="list-style-type: none"> Turn off the LCD display for extended periods of time. Use a screen saver or a black and white image and run it for extended periods of time.

APPENDIX

6.3 Transporting the LCD Display

To transport the LCD display for repair or shipment, place the display in its original packaging carton.

- 1 Place the two foam cushions on each side of the LCD display for protection.**
- 2 Place the LCD display down in the box.**
- 3 Place the accessories box on the designated area (if necessary).**
- 4 Close and tape the box.**

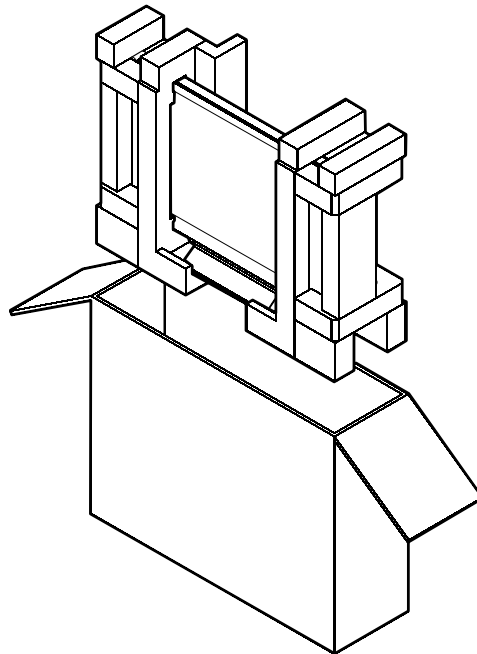

CHAPTER 7: SPECIFICATIONS

7.1 Display Specifications

HX-24E		
Panel	Panel Type	LED-Backlit TFT LCD (VA Technology)
	Panel Size	23.6"
	Max. Resolution	FHD 1920 x 1080
	Pixel Pitch	0.272 mm
	Brightness	250 cd/m ²
	Contrast Ratio	20,000,000:1 (DCR)
	Viewing Angle (H/V)	178°/178°
	Display Colour	16.7M
	Response Time	5 ms
	Surface Treatment	Anti-Glare Treatment (Haze 25%), 3H Hard Coating
Frequency (H/V)	H Freq.	24 kHz-83 kHz
	V Freq.	50 Hz-75 Hz
Input	SDI	BNC x 1
	DisplayPort	x 1
	HDMI	1.4 x 1
	DVI	24-Pin DVI-D
	VGA	15-Pin D-Sub x 1
	Composite (CVBS)	BNC x 1
Output	SDI	BNC x 1
	Composite (CVBS)	BNC x 1
External Control	RS232 In	2.5 mm Phone Jack
Other Connectivity	USB	2.0 x 1 (Service Port)
Audio	Audio In	Stereo Audio Jack (3.5 mm) Stereo Audio Jack (RCA)
	Internal Speakers	2W x 2
SDI Format	3G-SDI (SMPTE 424M)	1080p @50/60fps
	HD-SDI (SMPTE 292M)	720p @25/30/50/60fps, 1080p @24/25/30/50/60fps 1080i @50/60fps
	SD-SDI (SMPTE 259M)	480i @60fps, 576i @50fps
Power	Power Supply	External
	Power Requirements	DC 12V, 2.5A
	On Mode	22W (On)
	Stand-by Mode	< 0.5W
	Off Mode	< 0.5W
Glass	Thickness	3.0 mm (0.12")
	Reflection Rate	< 1%
	Transmission Rate	> 97%
	Hardness	> 9H
Operating Conditions	Temperature	0°C-40°C (32°F-104°F)
	Humidity	10%-90% (non-condensing)
Storage Conditions	Temperature	-20°C-60°C (-4°F-140°F)
	Humidity	5%-95% (non-condensing)
Mounting	VESA FPMPMI	Yes (100 x 100 mm & 75 x 75 mm)
Stand	Tilt	0° to 15°
Security	Kensington Security Slot	Yes

SPECIFICATIONS

HX-24E		
Dimensions	Product with Base (W x H x D)	562.4 x 396.8 x 155.0 mm (22.1" x 15.6" x 6.1")
	Product w/o Base (W x H x D)	562.4 x 352.6 x 56.2 mm (22.1" x 13.9" x 2.2")
	Packaging (W x H x D)	662.0 x 511.0 x 210.0 mm (26.0" x 20.1" x 8.3")
Weight	Product w/o Base	7.3 kg (16.0 lb)
	Product with Base	7.9 kg (17.4 lb)
	Packaging	9.9 kg (21.8 lb)

Note:

- ◆ All specifications are subject to change without prior notice.

7.2 Display Dimensions

7.2.1 HX-24E Dimensions

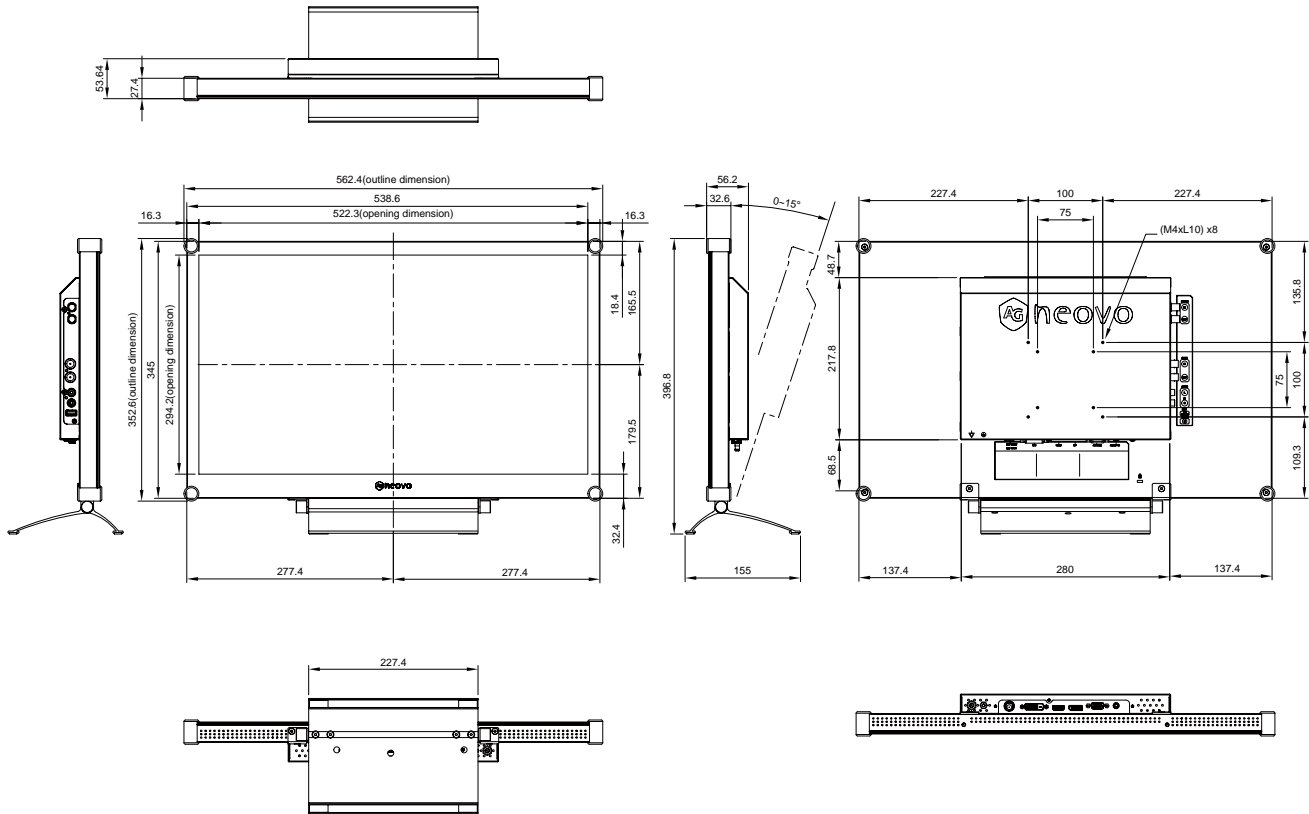

AG Neovo

Company Address: 5F-1, No. 3-1, Park Street, Nangang District, Taipei, 11503, Taiwan.

Copyright © 2019 AG Neovo. All rights reserved.

HX4E00_UM_V011